

Coupling for a main shaft of machine tools

SERVO FLEX SFM - SS/DS Operation Manual

1. Before using

- 1-1 After opening the package P. 1
- 1-2 Product shape and component name P. 1

2. Attentions for safety

- 2-1 Attentions for construction P. 2
- 2-2 Attentions for assembling P. 3
- 2-3 Attentions for driving P. 3 - 4
- 2-4 Attentions for safe maintenance P. 4
- 2-5 Attentions for disposal P. 5

3. Installation

- 3-1 Attentions for transport P. 5
- 3-2 Installation place and usage environment P. 5
- 3-3 How to install P. 5 - 6
- 3-4 Maximum permissible misalignment P. 6
- 3-5 Tightening torque of pressure bolt P. 6

4. Uninstallation

- 4-1 Attentions for uninstallation P. 7
- 4-2 How to uninstall P. 7

5. History of revision of this manual P. 8

Be sure to read this operation manual carefully before using SERVOFLEX.
This operation manual must be hand to final user without any fail.



1. Before using

1-1 After opening the package.

Please check the followings;

- (1) Please confirm whether proper products are packed as your order.
- (2) Please confirm whether the products are free from deformation or any damages while transport.

Please contact with our sales office if you have any concerns after checking above.

1-2 Product shape and component name

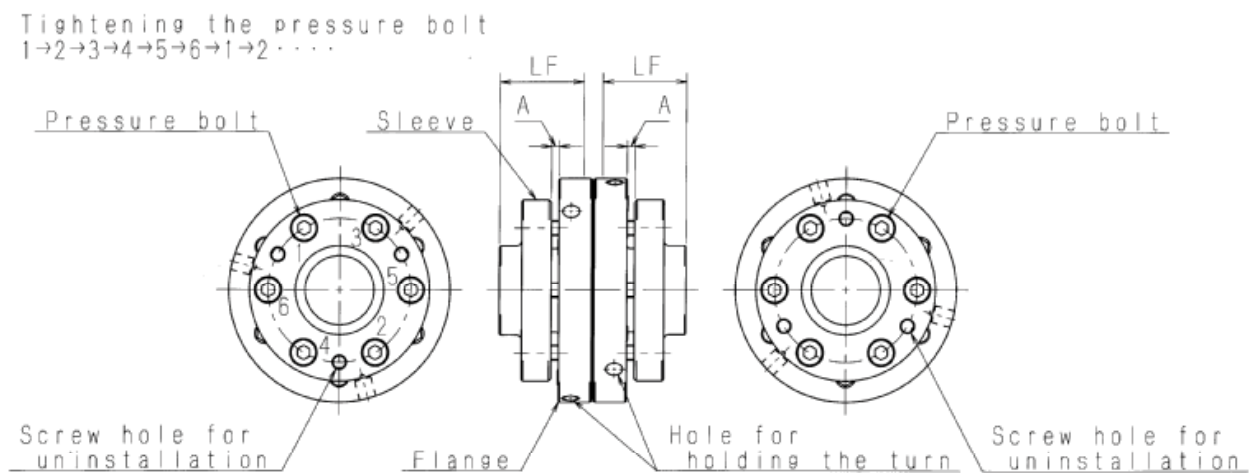

Outline figure 1 (SFM-SS)

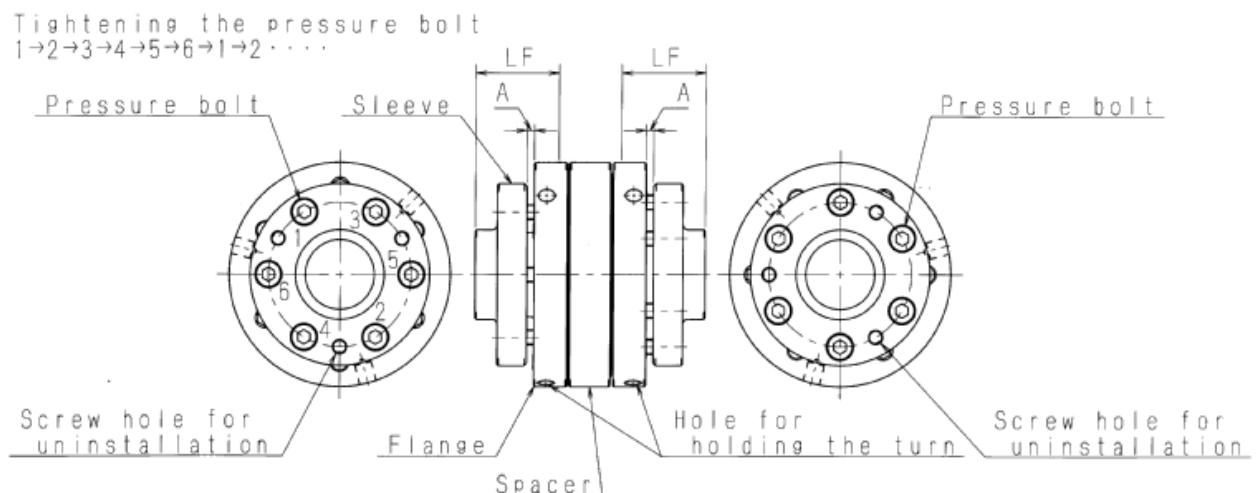



Outline figure 2 (SFM-DS)

2. Pay attention for safety

Please read operation manual or technical materials before using this product. Pay attention to handle this product safely.

In this operation manual, each safety requirements are ranked and distinguished as “danger” and “attention”

	Danger:	There is a possibility of death or serious injury by improper use.
	Attention:	There is a possibility of injury or material damage by improper Use.

Please contact with our sales office to investigate our product application to the following cases individually;

To the devices - nuclear power, aerospace, medical, mass-transportation or other various kind of safety devices - in which our product malfunction or operational error may have a harmful influence on human life or body.

Please pay attention for safety countermeasures on your machine to prevent unexpected malfunction or an accident, although we guarantee our quality control of our product sufficiently.

Please keep this manual carefully whenever you need to read, and make sure to hand this manual over to final users.

2-1 Attention for construction

	Danger	Make sure to provide safety cover.
---	--------	------------------------------------



Safety cover provided

Don't touch the product while operating. Otherwise you may be injured. Make sure to provide safety cover to prevent such an accident.

Also, make sure to provide safety device that enables operation stop when cover is opened.

	Danger	Don't use under inflammable or explosive environment.
---	--------	---



Danger of inflammable

Never use this product under the conditions or environment filled with inflammable and explosive oil, fat, and gases.

	Danger	Provide safety device.
---	--------	------------------------



Enforce

Product may be separated into driven and drive sections completely when broken or damaged. Make sure to provide safety device, i.e. safety brake system, to prevent an accident.

2-2 Attention when assembly

 Danger	Make sure to tighten screws and bolts.
--	--



Enforce

Insufficient tightening bolts and screws may cause breakages or performance deterioration of the product. Tighten bolts and screws at the specified torque to remove any hazards.

 Danger	Never supply main power during installation.
--	--



Prohibited

Make sure to confirm main power is shut down before installing the product. Otherwise, you may be injured by an accidental operation.

 Attention	Make sure to assemble within the maximum permissive misalignment.
---	---



When installing product, the maximum permissive misalignment must be secured as specified. Otherwise, product and machine may be damaged while operating with unspecified misalignment.

 Attention	Don't use unspecified bolts, screws, and collars.
---	---



Prohibited

Unspecified bolts, screws and collars may cause damages to the product. Make sure to use Miki Pulley's specified bolts, screws and collars.

2-3 Attention for operating

 Danger	Do not rotate the shaft over the maximum permissive speed.
--	--



Prohibited

Operation over the maximum permissive speed may damages to both product and machine. Never operate the product over the maximum Permissive speed.

 Danger	Do not touch the product while operation.
--	---



Don't touch

Never touch the product while rotational operation. Otherwise, you may be injured.

 Attention	Do not use the product over the maximum permissive torque.
--	--



Operation over the maximum permissive torque may damage to both product and machine. Never operate the product over the maximum permissive torque.

 Attention	Stop operation soon after abnormal noise or vibration occurred.
--	---



When you find abnormal nose or vibration, there must be something wrong with the machine or the product. If it is ignored, the machine may be broken. Stop the operation to check the machine and product.

 Attention	Do not use the product under the environment that may affect the product.
--	---



Never use the product under the environment that may affect the product (exposed to chemical or strongly corrosive places or extremely high and low temperature).

 Attention	Never use the product when taper lock slips..
--	---



Using the product under the slipping condition will generate heat and finally damage the product or have a harmful influence on the product.
Never use the product when taper lock slips.

 Attention	Use the product within our specified "misalignment capacity."
--	---



Install the product to a machine within our specified "maximum permissible misalignment." Operating the product out of the maximum permissible misalignment can lead to product damage or an adverse influence on the machine.

2-4 . Attentions for maintenance

 Danger	Never supply the power during maintenance.
---	--



Be sure to confirm the main power is shut down before maintenance. Otherwise you will be injured by unexpected motion of the machine.

 Attention	Never break up the product.
---	-----------------------------



Never break up the product assembled in Miki Pulley.
It will cause some trouble.

Never break up

2-5 . Attentions for disposal

 Danger	Do not leave the product where little kids will play game.
--	--

 Attention	Ask industrial wastes trader for disposal in order not to have a harmful influence on environment.
---	--

3 . Installation

3-1 Attentions for transport

- Be careful to treat product to be free from any damages while transport.
- Be careful to treat product to prevent the elements from any impacts.

3-2 Installation place and usage environment

- Please do not use product in high temperature or humidity and under dusty environments.
- Please do not use product at any places exposed to the range over the operating acceptable temperature. (from -30 degrees to 120 degrees)
- Please do not use product at any places exposed to corrosive gas, fluid, and chemical spray.
- Please do not used outside, since the product has neither water-resistance nor corrosion-resistance.
- Please do not use product at any places where a strong oscillation occur.

3-3 How to install

3-3-1 Attentions for installation

- Please shut down main power firmly before installing the product and confirm the safety to prevent accidental operation.
- Be careful to install the membrane so as not to injure yourself at the membrane of the product.
- Tolerance of the shaft for standard products must be within h7 class.
- Please do not tighten the pressure bolt before installing the shaft.
- Please do not break up the product, since the pressure bolt and the taper are lubricated with grease.
- Remove rust, dust, and grease on the shaft by a piece of cloth. Especially, a grease or oil containing molybdenum disulfide or extreme-pressure that decrease the friction pretty much must be removed completely off by degreasing agent, i.e. thinner.

3-3-2 How to install 1 (fixing on each side)

1. Install the coupling on the shaft of servomotor. The length of the installed shaft bore should be secured LF (refer to outline figure). LF differs depending upon the size of the coupling. Please refer to dimensional drawing and catalog.
2. Tighten the pressure bolts lightly in a diagonal order shown in outline figure. If the product turns, hold the turn by inserting a stick (or L wrench) into a hole on the flange.
3. Adjust the flange part and circumference with hitting carefully to bring deflection close to 0 (zero) as possible, with applying a dial indicator to the flange part or

outer diameter of servomotor installation side, and rotating the shaft by hand lightly. While adjusting, tighten the pressure bolts in order and finally tighten with rated torque shown in “3-5 tightening torque and bolt size”.

4. Make sure all pressure bolts of servomotor installation side are tightened with rated torque and the value of deflection is slight.
5. Install the servomotor with coupling attached on the machine. Installing the coupling in the spindle, adjusting the attachment position (in-low) of motor, and be careful for there to be no deformation of membrane. And the length of the installed shaft bore to the spindle should be secured LF.
6. Tighten the pressure bolts of the spindle installation side in order and finally tighten with rated torque.

3-3-3 How to install 2 (fixing after adjusting the center of the shaft)

1. Install the coupling on the shaft of servomotor.
2. Attach the spindle motor on the machine.
3. Adjust the attachment position (in-low) of motor and align the shafts so that the coupling can slide between the shaft of servomotor and the spindle smoothly.
4. Positioning the coupling on the shaft, and tighten the pressure bolts in order. The length of installed shaft bore is same as “How to install 1”.
5. Finally tighten with rated torque same as “How to install 1”.

*In order to prevent the pressure bolts from loosening, we recommend to tighten pressure bolts again with rated torque after a certain period of running

*When using high speed rotating spindle motor, alignment should be close to 0 (zero) as possible. It may have a bad influence on vibration, noise and processing accuracy.

3-4 Maximum permissible misalignment

When using the products (standard products), following permissive misalignment capacity must be secured.

	SFM-090		SFM-100		SFM-120		SFM-140	
	SS	DS	SS	DS	SS	DS	SS	DS
Parallel offset (mm)	0.02	0.03	0.02	0.31	0.02	0.38	0.02	0.44
Angular misalignment (degree)	1	1 (one side)	1	1 (one side)	1	1 (one side)	1	1 (one side)
Axial displacement (mm)	±0.6	±1.2	±0.7	±1.4	±0.8	±1.6	±1.0	±2.0

3-5 tightening torque and bolt size

	Pressure bolt size	Tightening torque (N·m)
SFM-090/100/120	M6	14
SFM-140	M8	34

4.Uninstallation

4-1 Attentions for uninstallation

- Please shut down main power firmly before installing the product and confirm the safety to prevent accidental operation.
- Be careful to uninstall the membrane so as not to injure yourself at the membrane of the product.
- Be careful to uninstall the broken coupling as the part is very sharp to hurt you.

4-2-1 How to uninstall 1 (Using the screw bore for uninstallation)

1. Loosen all pressure bolts sufficiently. These can be taken off completely.
2. Insert bolts in screw bores for uninstallation. The removed pressure bolts in 1 can be used.
3. The shaft will be released from the coupling by loosening bolts equally.

4-2-2 How to uninstall 2

1. Loosen all pressure bolts sufficiently. These can be taken off completely.
2. Insert flat-blade screwdrivers in the crevice between sleeve and flange (“A” part shown in outline figure), and release by hitting carefully in the direction perpendicular to the shaft, or using the principle of leverage. Fully keep in mind that there is a possibility of damaging the coupling and pressure bolts by flat-blade screwdrivers.
3. If it is difficult to release, insert flat-blade screwdrivers in different parts of crevice and repeat the above.

5 . History of revision of this manual

The mark of revision is written after the manual number shown right upperside of this manual.

TRS-SFM003-01

└── Revision mark

Mark of revision	Date of revision	Revised part, content of revision, etc.

Miki Pulley Co., Ltd

461 IMAI-MINAMI-CHO, KAWASAKI-City, Kanagawa, Japan.

TEL: 044-733-4371

FAX: 044-711-2431

Branch; Tokyo, Osaka, Nagoya,